

Loogikamõistatuste lahendamise Eesti koondise valikvõistlused 2023

1. Lihtne nagu ABC

	C		C		
A	B		A	C	
A	A	C		B	
		B	C		A
A		A	B		C
C	C			A	B
	C		B		

2. Futoshiki

4	2	1	3	5
5	3	2	4	1
1	4	3	5	2
2	5	4	1	3
3	1	5	2	4

3. Nurikabe

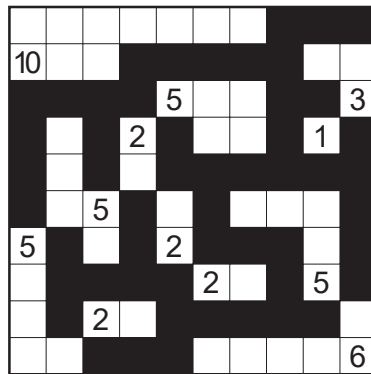

4. Hiina müür

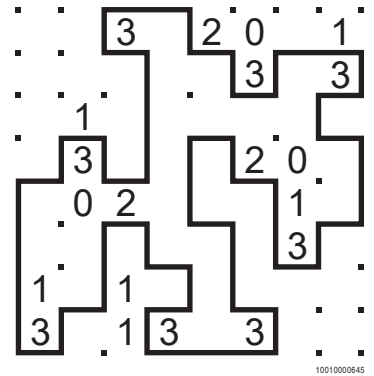

5. Laevade pommitamine

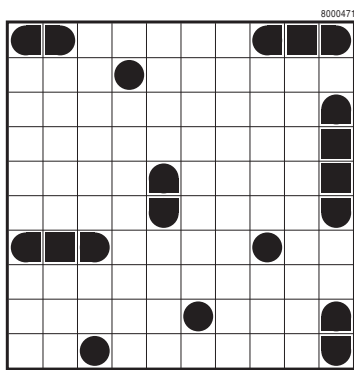

6. Jaapani mõistus

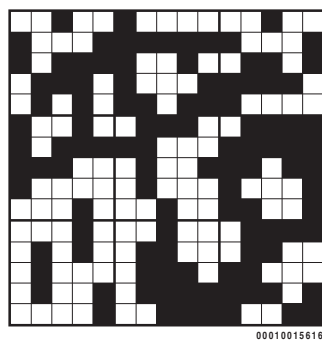

7. Jaapani mosaiik

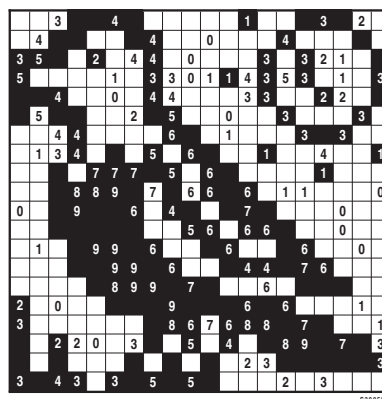

8. Telklaager

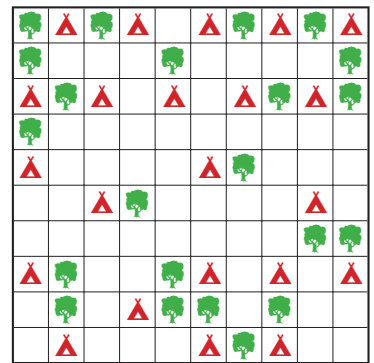

9. Enigma

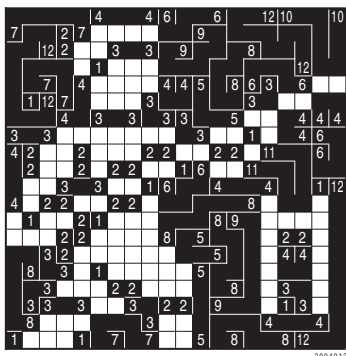

10. Kakuro

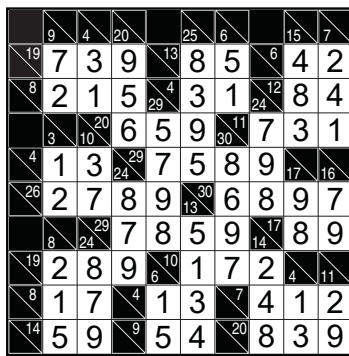

11. Hitori

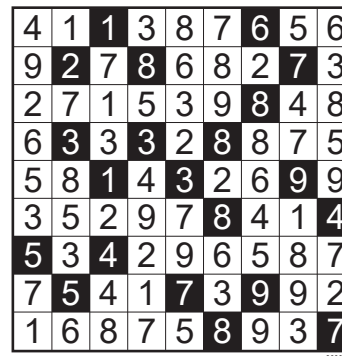

12. Hashi ehk sillad

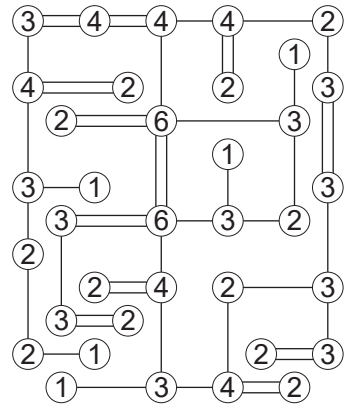

13. Kalkudoku

11+	4÷	2-	1-	
5	4	3	2	1
2	1	5	4	3
4	6+	2	1	3
10+		5	2	1
3×		3	4	5

14. Pilvelõhkjad

	2			
	↓			
3→	4	3	2	1
	2	1	3	5
	5	2	1	4
	1	5	4	3
3→	3	4	5	2
				←4
				↑
				5

15. Suguru

1	2	4	3	5	1	2	3	4	5
3	5	6	1	2	3	4	5	7	2
6	1	2	7	6	5	6	1	3	6
7	4	3	4	1	2	3	7	4	2
2	1	2	5	3	4	1	5	1	5
3	6	4	6	2	5	3	6	3	2
1	5	1	3	4	1	4	2	5	4
3	4	2	5	7	2	3	1	3	1
1	6	3	1	4	5	6	5	4	6
4	5	2	5	2	7	4	3	1	2